

**05-3308-S2-00U**

V0

## BIT Signal



### Description

for indoor use.

For downlighting. Structure material: Aluminium. Structure finish: Brushed. Diffuser material: Methacrylate. Diffuser finish: Transparent. Warranty: 5 Years.

**Finish**  
Brushed  
Transparent

**Material**  
Aluminium  
Methacrylate

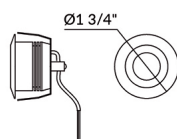

1 1/2"



### TECHNICAL CHARACTERISTICS

#### Light source

Light source: LED CREE  
Output (W): 2.3W  
Total power consumption (W): 2.3  
Color temperature: Warm White - 3000K  
Qty Leds: 1  
Bin / Grup: 7C1 o 7B4  
Photobiological risk: RG2

#### GEAR

This item requires gear. It is not included.  
Voltage / Frequency: max. 700mA

#### Luminaire

Warranty: 5 Years

#### Logistics

EAN Code: 8435381432874  
Net Weight (Lb): 0.1  
Weight in Kg (packaged): 0.070  
Packing: 60 x 60 x 45  
Masterbox: 100

35

0-20

The photograph may not match the reference exactly. Please read the product description to identify the finish.

# REF: 05-3307U / 05-3308U

FIGURE N° 1. UNPACK THE FIXTURE: CHECK THE CONTENTS OF THE BOX. YOU SHOULD RECEIVE:

6

FIGURE N° 1. DÉBALLER LE PLAFONIER: VÉRIFIER LE CONTENU DU CARTON, VOUS DEVEZ RECEVOIR:

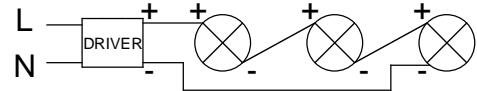
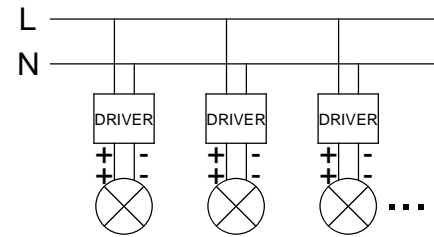
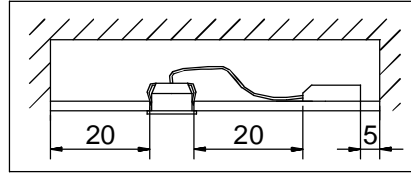
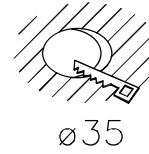
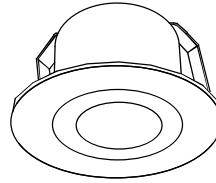
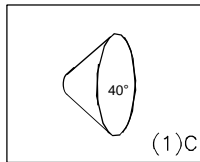
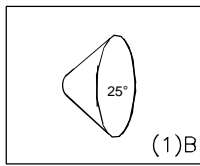
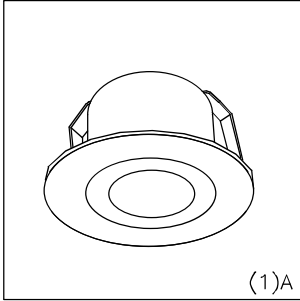

## INSTALLATION INSTRUCTIONS FOR HANGING FIXTURES

FIGURE 3, 4 AND 5 MOUNTING HARDWARE.  
NOTE: TEST THE CONNECTOR BY GENTLY PULLING IT. IF IT PULLS OUT THE CONNECTION, TRY AGAIN TILL YOU HAVE A FIRM CONNECTION. MAKE SURE NO BARE STRANDS OF WIRE STICK OUT FROM UNDER THE CONNECTORS.

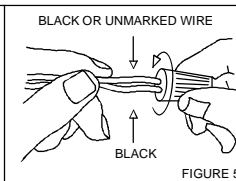
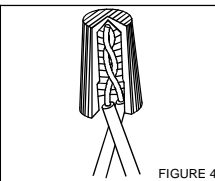
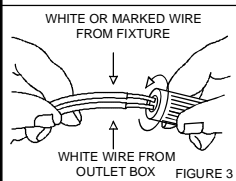

## INSTRUCTIONS D'INSTALLATION POUR PLAFONNIERS

FIGURE 3, 4 ET 5 MONTAGE DE L'ÉQUIPE.  
IMPORTANT: ESSAYER DE TIRER LE CÂBLE D'ALIMENTATION DOUCEMENT. S'IL SORT DE LA CONNECTION, IL FAUDRAIT ASSURER QUE LA CONNECTION SOIT FERME. S'ASSURER QUE LES FILS DES CÂBLES NE SONT PAS À DÉCOUVERT DU CONNECTEUR.

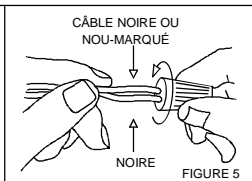
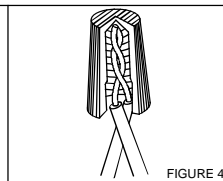
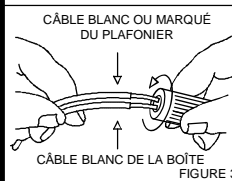

**CAUTION:**  
"Warning", "This product is to be installed by a qualified electrician only."

"Suitable for dry locations only"

**ATTENTION:**  
"Attention", le raccordement électrique sera effectué par un technicien électrique qualifié"

"Adéquat seulement en lieux secs."

**CAUTION:**

- 1.- Wrong lighting installation can be dangerous for your safety.
- 2.- Before starting, disconnect the power by turning off the general switch of the electric installation.
- 3.- Install light bulbs (not provided) that must not exceed markings on the fixture.
- 4.- To change the bulbs, disconnect the power by turning off the general switch and wait for the bulbs cool down.

**INSTALLATION:**

- 1.- Make electrical connections, carefully read the Electrical Connection section.
- 2.- Assemble lighting onto the outlet box as shown on fig. 6, 7, 8, 9 & 10

**ELECTRICAL CONNECTIONS:** (See fig. 3,4 y 5)

- 1.- Connect the white wire from the fixture to the white wire of the electric installation.
- 2.- Connect the black wire from the fixture to the black wire of the electric installation.
- 3.- Connect the grounding conductor from the fixture to the grounding wire of the electric installation.
- 4.- Spread out the electrical wires so that the black ones are on one side of the outlet box and the white ones are on the other side, and carefully introduce them into the outlet box.

**ATTENTION:**

1. Une mauvaise installation peut compromettre votre sécurité.
2. Déconnecter la tension du réseau d'alimentation avant de réaliser toute opération.
3. Installer les ampoules (non fournies), ne pas utiliser d'ampoules d'un autre type ou d'une puissance supérieure à celle indiquée sur l'étiquette de la lampe.
4. Pour changer les ampoules, déconnecter la tension du réseau d'alimentation et laisser refroidir les ampoules.

**INSTALLATION:**

1. Connecter au réseau, lire attentivement la section de "Raccordements électriques"
2. Installer l'appareil à la boîte de distribution comme indiqué dans les dessins 6, 7, 8, 9 et 10.

**RACCORDEMENTS ÉLECTRIQUES (dessins 3,4 et 5)**

1. Connecter le câble blanc de l'appareil au câble blanc de l'installation électrique.
2. Connecter le câble noir de l'appareil au câble noir de l'installation électrique.
3. Connecter le câble conducteur de prise de terre au câble de prise de terre de l'installation électrique.
4. Distribuer les câbles pour que tout le câblage noir soit par dehors et le câblage blanc soit par dedans. Ajuster et immobiliser à la boîte sans coincer aucun câble.



# REF: 05-3307U / 05-3308U

