

WILSON Wall fixture



Description

for outdoor use.

For uplighting and downlighting. Structure material: High purity aluminium. Structure finish: White. Blades material: . Blades finishes: NA. Diffuser material: Glass. Diffuser finish: Matt. UV protection. Warranty: 5 Years.

Finish

White
Matt
NA

Material

High purity aluminium
Glass

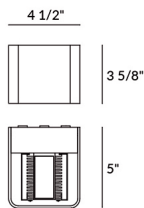

TECHNICAL CHARACTERISTICS

Light source

Light source: LED
Output (W): 9W
Total power consumption (W): 8.2
Color temperature: LED warm-white
3000K
CRI: 80
Real Lumen: 225
Qty Leds: 6
Lm/Real W: 27
Life Time: 50.000h L80B20
Bin / Grup: 7C1-7B4
UGR: 7.0

GEAR

Gear included: Yes, electronic
Power Factor: 0.52

Luminaire

Double cable exit: No
Seaside: No
Uv Protection: Yes
Warranty: 5 Years

Logistics

Energy Efficiency: LED A++
EAN Code: 8435381456023
Net Weight (Lb): 2.16
Weight in Kg (packaged): 1.165
Packing: 125 x 110 x 165
Masterbox: 4

The photograph may not match the reference exactly. Please read the product description to identify the finish.

Luminaire

 Code 05-9683
 Name 05-9683

Measur.

 Code 20130314006
 Name 05-9683

Luminaire Flux	225.03 lm	Luminaire Power	8.30 W	Efficacy	27.11 lm/W	Efficiency	37.51%
Lamps Flux	600.00 lm	Maximum value	110.20 cd/klm	Position	C=330.00 G=177.00	CG	Asymmetrical
Rectangular Luminaire Rectangular Luminous Area	Length Length	100 mm 100 mm	Width Width	80 mm 80 mm	Height Height	35 mm 35 mm	
Horizontal Luminous Area Emitting area on Plane 0° Emitting area on Plane 90°	0.008000 m2 0.003500 m2 0.002800 m2		Emitting area on Plane 180° Emitting area on Plane 270° Glare area at 76°	0.003500 m2 0.002800 m2 0.005331 m2			
Coordinate system Date Measurement Distance	CG 15-03-2013 0.00		Symmetry Type Maximum Gamma Angle Measurement Flux	Asymmetrical 180 600.00 lm			
Operator Temperature Humidity Notes	25.00 °C 60.00 %		Source Voltage [V] Source current [A] Photocell				

Luminaire Lamps						
Line	Code	Name	Flux [lm]	Pow. [W]	Q.ty	
	11	11	100.00	1.38	6	
C.I.E. F UTE	70 99 100 49 38 0.18 B + 0.19 T	D DIN 5040 B NBN	C52 BZ 2			

100mm x 80mm

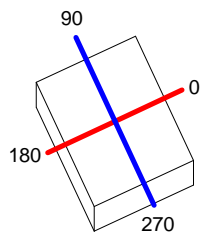

C Halfplanes

180.0 — 0.0

270.0 — 90.0

ULOR 19.07 %

DLOR 18.43 %

RN 50.86 %

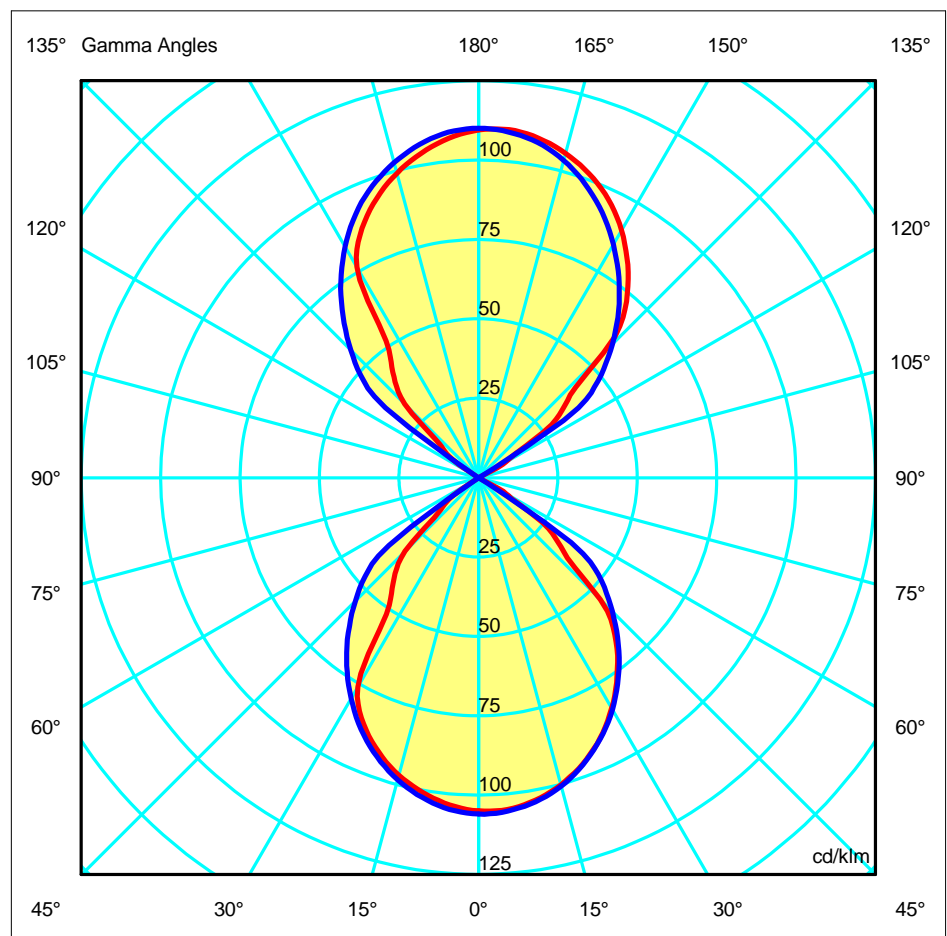

Luminaire

Code 05-9683

Name 05-9683

Measur.

Code 20130314006

Name 05-9683

Luminaire Flux	225.03 lm	Luminaire Power	8.30 W	Efficacy	27.11 lm/W	Efficiency	37.51%
Lamps Flux	600.00 lm	Maximum value	110.20 cd/klm	Position	C=330.00 G=177.00	CG	Asymmetrical

Luminous Intensity Table cd/klm Table 1/3

	C 0.00	C 30.00	C 60.00	C 90.00	C 120.00	C 150.00	C 180.00	C 210.00	C 240.00	C 270.00	C 300.00	C 330.00
G 0.0	104.90	104.73	104.30	105.93	105.60	105.37	104.90	104.73	104.30	105.93	105.60	105.37
G 1.0	105.02	104.77	104.43	105.98	105.50	105.28	104.77	104.63	104.23	105.85	105.67	105.43
G 2.0	105.10	104.72	104.42	105.90	105.37	105.18	104.53	104.45	103.97	105.65	105.67	105.35
G 3.0	105.08	104.62	104.37	105.83	105.15	104.97	104.23	104.20	103.67	105.43	105.53	105.25
G 4.0	105.03	104.48	104.27	105.62	104.80	104.67	103.83	103.90	103.33	105.18	105.30	105.05
G 5.0	104.85	104.27	104.07	105.38	104.43	104.37	103.45	103.53	102.93	104.85	105.12	104.77
G 6.0	104.63	103.98	103.83	105.10	104.07	103.98	103.00	103.13	102.57	104.42	104.88	104.43
G 7.0	104.35	103.57	103.58	104.82	103.68	103.52	102.47	102.70	102.12	103.97	104.60	104.05
G 8.0	104.00	103.18	103.28	104.48	103.22	103.03	101.93	102.18	101.60	103.48	104.17	103.65
G 9.0	103.60	102.68	102.92	104.07	102.75	102.52	101.32	101.68	101.00	102.88	103.67	103.13
G 10.0	103.13	102.12	102.48	103.60	102.25	102.00	100.68	101.12	100.35	102.25	103.18	102.60
G 11.0	102.63	101.55	101.95	103.10	101.70	101.42	99.98	100.52	99.63	101.62	102.53	101.95
G 12.0	102.05	100.93	101.38	102.57	101.05	100.80	99.30	99.78	98.93	100.85	101.88	101.27
G 13.0	101.47	100.27	100.75	101.92	100.40	100.12	98.58	99.08	98.10	100.13	101.17	100.55
G 14.0	100.82	99.53	100.02	101.25	99.62	99.38	97.78	98.30	97.25	99.30	100.45	99.77
G 15.0	100.15	98.82	99.23	100.55	98.87	98.67	96.97	97.45	96.43	98.43	99.60	98.92
G 16.0	99.42	98.00	98.52	99.83	98.03	97.85	96.10	96.65	95.52	97.57	98.73	98.05
G 17.0	98.57	97.17	97.72	98.97	97.17	97.00	95.15	95.75	94.52	96.63	97.90	97.08
G 18.0	97.77	96.25	96.88	98.07	96.28	96.17	94.13	94.80	93.53	95.58	96.98	96.10
G 19.0	96.90	95.30	95.97	97.17	95.37	95.25	93.03	93.83	92.47	94.58	95.95	95.07
G 20.0	95.93	94.37	95.07	96.13	94.35	94.27	91.93	92.82	91.43	93.45	94.93	94.05
G 21.0	94.97	93.38	94.08	95.10	93.28	93.22	90.80	91.77	90.33	92.38	93.85	92.97
G 22.0	93.90	92.28	93.10	94.07	92.18	92.15	89.63	90.67	89.18	91.25	92.73	91.87
G 23.0	92.80	91.17	92.05	93.03	91.10	91.03	88.30	89.57	88.00	90.08	91.62	90.67
G 24.0	91.72	90.00	90.93	91.92	89.93	89.87	87.02	88.37	86.70	88.77	90.43	89.50
G 25.0	90.53	88.85	89.82	90.73	88.63	88.72	85.58	87.15	85.47	87.45	89.23	88.20
G 26.0	89.28	87.58	88.62	89.55	87.42	87.53	84.13	85.80	84.22	86.10	87.92	86.93
G 27.0	87.98	86.35	87.37	88.33	86.13	86.17	82.48	84.47	82.83	84.70	86.60	85.55
G 28.0	86.67	84.98	86.12	87.05	84.70	84.75	80.75	83.02	81.47	83.20	85.20	84.15
G 29.0	85.22	83.55	84.77	85.72	83.32	83.33	78.77	81.57	80.08	81.72	83.83	82.77
G 30.0	83.83	82.15	83.38	84.30	81.87	81.83	76.03	79.95	78.57	80.22	82.32	81.33
G 31.0	82.42	80.67	82.00	82.83	80.33	80.17	72.02	78.33	77.13	78.70	80.87	79.78
G 32.0	80.87	79.17	80.58	81.35	78.75	78.53	65.33	76.63	75.55	77.10	79.28	78.28
G 33.0	79.22	77.68	79.05	79.88	77.20	76.67	57.25	74.72	74.02	75.57	77.78	76.72
G 34.0	77.70	76.08	77.53	78.32	75.63	74.63	51.85	72.57	72.48	73.92	76.25	75.10
G 35.0	76.07	74.43	76.07	76.78	73.97	72.00	48.98	69.82	70.80	72.33	74.63	73.50
G 36.0	74.40	72.80	74.48	75.13	72.37	68.42	47.13	65.52	69.20	70.63	73.07	71.83
G 37.0	72.80	71.20	72.92	73.53	70.70	62.37	45.57	59.32	67.48	68.98	71.42	70.15
G 38.0	71.08	69.53	71.37	71.88	69.05	55.43	44.18	52.30	65.77	67.25	69.80	68.42
G 39.0	69.23	67.85	69.78	70.23	67.37	49.67	42.73	47.55	64.02	65.55	68.17	66.75
G 40.0	67.38	66.18	68.08	68.47	65.68	46.38	41.37	44.67	62.28	63.75	66.43	64.98
G 41.0	65.42	64.38	66.50	66.73	63.87	44.20	40.02	42.83	60.55	61.95	64.70	63.28
G 42.0	63.40	62.53	64.80	64.97	62.10	42.57	38.53	41.28	58.73	60.22	63.00	61.40
G 43.0	61.05	60.72	63.12	63.15	60.23	41.10	36.98	39.77	56.93	58.43	61.30	59.58
G 44.0	58.38	58.83	61.45	61.33	58.43	39.63	35.12	38.40	55.08	56.57	59.55	57.62
G 45.0	54.27	56.75	59.67	59.62	56.48	38.27	32.77	37.00	53.27	54.70	57.85	55.67
G 46.0	47.63	54.55	57.90	57.78	54.65	36.85	28.87	35.67	51.42	52.93	56.05	53.57
G 47.0	41.43	51.87	56.20	56.07	52.78	35.42	23.43	34.23	49.43	51.20	54.25	51.08
G 48.0	37.67	48.33	54.42	54.25	50.77	33.98	18.83	32.78	47.48	49.33	52.55	48.08
G 49.0	35.53	42.75	52.65	52.55	48.72	32.30	16.73	31.10	45.23	47.28	50.77	43.40
G 50.0	33.83	36.88	50.93	50.57	46.37	30.45	15.52	29.08	42.73	45.08	49.07	37.60
G 51.0	32.22	33.07	49.25	48.52	43.70	27.85	14.48	25.83	39.43	43.10	47.27	32.90
G 52.0	30.63	31.07	47.37	46.53	39.97	23.45	13.50	20.98	35.30	39.98	45.50	30.43
G 53.0	29.08	29.40	45.62	44.15	35.55	18.45	12.57	16.60	30.75	35.35	43.63	28.77
G 54.0	27.22	27.93	43.52	40.73	30.90	15.52	11.38	14.40	27.12	26.28	41.55	27.18
G 55.0	24.37	26.42	41.63	35.62	27.67	13.95	9.75	13.07	24.77	11.67	39.52	25.73
G 56.0	19.22	24.88	39.55	25.10	25.28	12.83	6.82	12.10	22.68	3.05	37.68	24.17
G 57.0	14.60	22.95	36.75	10.63	22.90	11.92	2.23	11.17	19.75	0.57	34.88	22.47
G 58.0	12.35	20.08	33.10	3.40	19.80	11.00	0.00	10.28	15.33	0.00	31.08	19.95
G 59.0	11.10	15.60	25.77	0.70	14.90	10.03	0.00	9.18	7.37	0.00	22.98	16.00
G 60.0	10.08	11.60	13.52	0.00	6.67	8.72	0.00	7.65	1.42	0.00	10.35	11.43
G 61.0	8.92	9.87	4.37	0.00	1.12	6.35	0.00	4.27	0.00	0.00	2.97	9.58
G 62.0	6.95	8.83	0.82	0.00	0.00	2.18	0.00	0.80	0.00	0.00	0.32	8.47
G 63.0	2.47	7.77	0.00	0.00	0.00	0.00	0.00	0.00	0.00	0.00	0.00	7.43
G 64.0	0.00	6.32	0.00	0.00	0.00	0.00	0.00	0.00	0.00	0.00	0.00	6.15
G 65.0	0.00	3.63	0.00	0.00	0.00	0.00	0.00	0.00	0.00	0.00	0.00	3.57
G 66.0	0.00	0.00	0.00	0.00	0.00	0.00	0.00	0.00	0.00	0.00	0.00	0.00
G 67.0	0.00	0.00	0.00	0.00	0.00	0.00	0.00	0.00	0.00	0.00	0.00	0.00
G 68.0	0.00	0.00	0.00	0.00	0.00	0.00	0.00	0.00	0.00	0.00	0.00	0.00
G 69.0	0.00	0.00	0.00	0.00	0.00	0.00	0.00	0.00	0.00	0.00	0.00	0.00
G 70.0	0.00	0.00	0.00	0.00	0.00	0.00	0.00	0.00	0.00	0.00	0.00	0.00
G 71.0	0.00	0.00	0.00	0.00	0.00	0.00	0.00	0.00	0.00	0.00	0.00	0.00
G 72.0	0.00	0.00	0.00	0.00	0.00	0.00	0.00	0.00	0.00	0.00	0.00	0.00

Luminaire

 Code 05-9683
 Name 05-9683

Measur.

 Code 20130314006
 Name 05-9683

Luminaire Flux	225.03 lm	Luminaire Power	8.30 W	Efficacy	27.11 lm/W	Efficiency	37.51%
Lamps Flux	600.00 lm	Maximum value	110.20 cd/klm	Position	C=330.00 G=177.00	CG	Asymmetrical

Luminous Intensity Table cd/klm Table 2/3

	C 0.00	C 30.00	C 60.00	C 90.00	C 120.00	C 150.00	C 180.00	C 210.00	C 240.00	C 270.00	C 300.00	C 330.00
G 73.0	0.00	0.00	0.00	0.00	0.00	0.00	0.00	0.00	0.00	0.00	0.00	0.00
G 74.0	0.00	0.00	0.00	0.00	0.00	0.00	0.00	0.00	0.00	0.00	0.00	0.00
G 75.0	0.00	0.00	0.00	0.00	0.00	0.00	0.00	0.00	0.00	0.00	0.00	0.00
G 76.0	0.00	0.00	0.00	0.00	0.00	0.00	0.00	0.00	0.00	0.00	0.00	0.00
G 77.0	0.00	0.00	0.00	0.00	0.00	0.00	0.00	0.00	0.00	0.00	0.00	0.00
G 78.0	0.00	0.00	0.00	0.00	0.00	0.00	0.00	0.00	0.00	0.00	0.00	0.00
G 79.0	0.00	0.00	0.00	0.00	0.00	0.00	0.00	0.00	0.00	0.00	0.00	0.00
G 80.0	0.00	0.00	0.00	0.00	0.00	0.00	0.00	0.00	0.00	0.00	0.00	0.00
G 81.0	0.00	0.00	0.00	0.00	0.00	0.00	0.00	0.00	0.00	0.00	0.00	0.00
G 82.0	0.00	0.00	0.00	0.00	0.00	0.00	0.00	0.00	0.00	0.00	0.00	0.00
G 83.0	0.00	0.00	0.00	0.00	0.00	0.00	0.00	0.00	0.00	0.00	0.00	0.00
G 84.0	0.00	0.00	0.00	0.00	0.00	0.00	0.00	0.00	0.00	0.00	0.00	0.00
G 85.0	0.00	0.00	0.00	0.00	0.00	0.00	0.00	0.00	0.00	0.00	0.00	0.00
G 86.0	0.00	0.00	0.00	0.00	0.00	0.00	0.00	0.00	0.00	0.00	0.00	0.00
G 87.0	0.00	0.00	0.00	0.00	0.00	0.00	0.00	0.00	0.00	0.00	0.00	0.00
G 88.0	0.00	0.00	0.00	0.00	0.00	0.00	0.00	0.00	0.00	0.00	0.00	0.00
G 89.0	0.00	0.00	0.00	0.00	0.00	0.00	0.00	0.00	0.00	0.00	0.00	0.00
G 90.0	0.00	0.00	0.00	0.00	0.00	0.00	0.00	0.00	0.00	0.00	0.00	0.00
G 91.0	0.00	0.00	0.00	0.00	0.00	0.00	0.00	0.00	0.00	0.00	0.00	0.00
G 92.0	0.00	0.00	0.00	0.00	0.00	0.00	0.00	0.00	0.00	0.00	0.00	0.00
G 93.0	0.00	0.00	0.00	0.00	0.00	0.00	0.00	0.00	0.00	0.00	0.00	0.00
G 94.0	0.00	0.00	0.00	0.00	0.00	0.00	0.00	0.00	0.00	0.00	0.00	0.00
G 95.0	0.00	0.00	0.00	0.00	0.00	0.00	0.00	0.00	0.00	0.00	0.00	0.00
G 96.0	0.00	0.00	0.00	0.00	0.00	0.00	0.00	0.00	0.00	0.00	0.00	0.00
G 97.0	0.00	0.00	0.00	0.00	0.00	0.00	0.00	0.00	0.00	0.00	0.00	0.00
G 98.0	0.00	0.00	0.00	0.00	0.00	0.00	0.00	0.00	0.00	0.00	0.00	0.00
G 99.0	0.00	0.00	0.00	0.00	0.00	0.00	0.00	0.00	0.00	0.00	0.00	0.00
G100.0	0.00	0.00	0.00	0.00	0.00	0.00	0.00	0.00	0.00	0.00	0.00	0.00
G101.0	0.00	0.00	0.00	0.00	0.00	0.00	0.00	0.00	0.00	0.00	0.00	0.00
G102.0	0.00	0.00	0.00	0.00	0.00	0.00	0.00	0.00	0.00	0.00	0.00	0.00
G103.0	0.00	0.00	0.00	0.00	0.00	0.00	0.00	0.00	0.00	0.00	0.00	0.00
G104.0	0.00	0.00	0.00	0.00	0.00	0.00	0.00	0.00	0.00	0.00	0.00	0.00
G105.0	0.00	0.00	0.00	0.00	0.00	0.00	0.00	0.00	0.00	0.00	0.00	0.00
G106.0	0.00	0.00	0.00	0.00	0.00	0.00	0.00	0.00	0.00	0.00	0.00	0.00
G107.0	0.00	0.00	0.00	0.00	0.00	0.00	0.00	0.00	0.00	0.00	0.00	0.00
G108.0	0.00	0.00	0.00	0.00	0.00	0.00	0.00	0.00	0.00	0.00	0.00	0.00
G109.0	0.00	0.00	0.00	0.00	0.00	0.00	0.00	0.00	0.00	0.00	0.00	0.00
G110.0	0.00	0.00	0.00	0.00	0.00	0.00	0.00	0.00	0.00	0.00	0.00	0.00
G111.0	0.00	0.00	0.00	0.00	0.00	0.00	0.00	0.00	0.00	0.00	0.00	0.00
G112.0	0.00	0.00	0.00	0.00	0.00	0.00	0.00	0.00	0.00	0.00	0.00	0.00
G113.0	0.00	0.00	0.00	0.00	0.00	0.00	0.00	0.00	0.00	0.00	0.00	0.00
G114.0	0.00	0.00	0.00	0.00	0.00	0.00	0.00	0.00	0.00	0.00	0.00	0.00
G115.0	0.00	2.93	0.00	0.00	0.00	0.00	0.00	0.00	0.00	0.00	0.00	3.75
G116.0	0.00	5.92	0.00	0.00	0.00	0.00	0.00	0.00	0.00	0.00	0.00	6.32
G117.0	1.82	7.45	0.50	0.00	0.00	0.08	0.00	0.00	0.00	0.00	0.00	7.63
G118.0	6.38	8.45	3.53	0.00	0.00	2.85	0.00	1.00	0.00	0.00	0.00	8.60
G119.0	8.65	9.38	12.88	0.00	1.67	6.77	0.08	4.85	0.00	0.00	1.22	9.52
G120.0	9.87	10.75	26.25	0.15	9.12	8.58	0.00	8.08	2.50	0.00	6.27	11.25
G121.0	10.90	14.60	32.82	1.55	16.35	9.62	0.00	9.50	10.53	0.00	19.17	15.82
G122.0	11.88	20.43	36.33	5.72	20.28	10.50	0.00	10.52	17.23	0.00	31.02	20.50
G123.0	13.73	23.85	38.85	18.38	22.95	11.28	2.50	11.33	20.92	0.15	36.57	23.45
G124.0	18.22	26.08	40.85	32.27	25.03	12.15	7.20	12.18	23.25	2.22	39.92	25.43
G125.0	24.67	27.75	42.92	38.47	27.73	13.17	9.90	13.07	25.12	11.05	42.27	26.97
G126.0	28.43	29.27	44.92	41.95	31.75	14.88	11.37	14.30	27.15	26.82	44.28	28.43
G127.0	30.58	30.80	46.72	44.43	36.35	18.37	12.42	16.48	30.53	36.67	46.43	29.97
G128.0	32.27	32.40	48.57	46.23	40.13	23.70	13.35	21.07	34.87	41.52	48.45	31.55
G129.0	33.92	34.10	50.37	48.50	43.15	27.50	14.17	26.08	39.60	44.85	50.33	33.35
G130.0	35.45	37.13	52.33	50.43	45.58	29.82	15.08	29.42	43.38	46.97	52.27	37.03
G131.0	37.13	43.18	54.15	52.32	47.62	31.48	16.20	31.38	46.12	49.10	54.08	43.55
G132.0	38.90	49.63	55.93	54.12	49.53	33.00	18.52	33.05	48.42	51.18	55.90	50.25
G133.0	41.80	54.17	57.80	55.88	51.50	34.38	23.38	34.52	50.60	53.12	57.82	54.48
G134.0	47.42	57.40	59.70	57.75	53.35	35.75	29.07	35.98	52.57	54.95	59.73	57.57
G135.0	55.72	59.85	61.60	59.60	55.28	37.08	32.95	37.32	54.57	56.87	61.55	59.93
G136.0	61.87	62.18	63.38	61.38	57.10	38.47	35.22	38.77	56.47	58.72	63.53	62.22
G137.0	65.32	64.25	65.15	63.25	58.87	39.92	37.03	40.17	58.33	60.67	65.37	64.27
G138.0	68.02	66.23	67.00	65.02	60.73	41.38	38.55	41.68	60.30	62.52	67.18	66.23
G139.0	70.30	68.25	68.77	66.87	62.48	43.05	40.03	43.23	62.15	64.45	68.98	68.27
G140.0	72.47	70.22	70.57	68.60	64.30	45.35	41.42	45.02	64.07	66.30	70.88	70.25
G141.0	74.45	72.07	72.28	70.37	66.03	48.90	42.82	47.77	65.90	68.20	72.65	72.13
G142.0	76.45	73.92	74.03	72.03	67.78	51.05	44.27	52.55	67.78	70.03	74.50	74.03
G143.0	78.35	75.70	75.68	73.68	69.47	61.87	45.70	59.27	69.57	71.98	76.23	75.83
G144.0	80.13	77.38	77.40	75.40	71.18	67.30	47.25	66.07	71.43	73.78	78.03	77.68
G145.0	81.93	79.10	79.02	77.10	72.92	70.60	49.17	70.90	73.17	75.52	79.70	79.40

Luminaire

Code 05-9683
Name 05-9683

Measur.

Code 20130314006
Name 05-9683

Luminaire Flux	225.03 lm	Luminaire Power	8.30 W	Efficacy	27.11 lm/W	Efficiency	37.51%
Lamps Flux	600.00 lm	Maximum value	110.20 cd/klm	Position	C=330.00 G=177.00	CG	Asymmetrical

Luminous Intensity Table cd/klm Table 3/3

	C 0.00	C 30.00	C 60.00	C 90.00	C 120.00	C 150.00	C 180.00	C 210.00	C 240.00	C 270.00	C 300.00	C 330.00
G146.0	83.58	80.83	80.60	78.68	74.53	73.05	52.03	73.82	74.97	77.23	81.45	81.30
G147.0	85.25	82.55	82.17	80.20	76.12	75.20	57.52	76.13	76.62	79.02	83.13	82.97
G148.0	86.90	84.13	83.70	81.78	77.80	77.18	65.75	78.10	78.32	80.68	84.72	84.68
G149.0	88.50	85.72	85.25	83.28	79.40	78.97	72.62	79.97	79.90	82.40	86.35	86.30
G150.0	90.05	87.28	86.72	84.88	81.07	80.65	76.63	81.65	81.52	83.98	87.92	87.93
G151.0	91.50	88.72	88.13	86.45	82.58	82.40	79.43	83.37	83.03	85.63	89.35	89.43
G152.0	92.92	90.20	89.60	87.92	84.20	83.98	81.53	84.90	84.58	87.15	90.85	90.97
G153.0	94.23	91.63	91.02	89.33	85.68	85.58	83.33	86.47	85.98	88.68	92.28	92.35
G154.0	95.52	92.93	92.33	90.78	87.12	87.07	85.08	87.87	87.35	90.12	93.57	93.75
G155.0	96.78	94.32	93.68	92.13	88.58	88.57	86.68	89.28	88.73	91.57	94.87	95.02
G156.0	97.90	95.47	94.88	93.45	90.00	89.95	88.22	90.58	90.10	92.97	96.10	96.28
G157.0	98.98	96.57	96.13	94.70	91.33	91.33	89.62	91.87	91.35	94.23	97.28	97.45
G158.0	100.00	97.73	97.27	95.98	92.73	92.63	91.07	93.05	92.67	95.45	98.37	98.58
G159.0	100.98	98.83	98.45	97.18	94.00	93.95	92.37	94.28	93.88	96.65	99.47	99.67
G160.0	101.90	99.82	99.55	98.37	95.25	95.22	93.68	95.40	95.03	97.78	100.53	100.63
G161.0	102.77	100.77	100.57	99.53	96.52	96.37	94.87	96.55	96.22	98.83	101.50	101.57
G162.0	103.62	101.72	101.53	100.60	97.67	97.50	96.10	97.60	97.33	99.83	102.47	102.50
G163.0	104.35	102.62	102.50	101.62	98.82	98.63	97.23	98.68	98.42	100.87	103.40	103.37
G164.0	105.10	103.47	103.37	102.60	99.90	99.73	98.28	99.70	99.48	101.80	104.22	104.22
G165.0	105.85	104.30	104.25	103.53	100.95	100.72	99.27	100.67	100.45	102.73	105.05	104.97
G166.0	106.47	105.03	105.12	104.42	101.88	101.67	100.30	101.58	101.40	103.58	105.78	105.72
G167.0	107.08	105.78	105.85	105.22	102.82	102.63	101.22	102.50	102.33	104.38	106.52	106.43
G168.0	107.63	106.43	106.57	105.95	103.67	103.48	102.12	103.30	103.18	105.20	107.22	107.07
G169.0	108.15	107.08	107.20	106.63	104.47	104.33	102.97	104.15	104.05	105.93	107.83	107.68
G170.0	108.63	107.65	107.72	107.28	105.22	105.07	103.78	104.88	104.82	106.63	108.37	108.18
G171.0	109.07	108.20	108.18	107.77	105.93	105.82	104.60	105.62	105.58	107.27	108.83	108.65
G172.0	109.42	108.65	108.55	108.22	106.55	106.48	105.33	106.25	106.23	107.88	109.23	109.10
G173.0	109.68	109.02	108.85	108.62	107.13	107.13	106.05	106.88	106.83	108.38	109.55	109.43
G174.0	109.92	109.33	109.08	108.97	107.65	107.73	106.68	107.48	107.38	108.85	109.77	109.72
G175.0	110.03	109.58	109.30	109.30	108.17	108.23	107.32	108.03	107.88	109.23	109.95	109.97
G176.0	110.07	109.73	109.50	109.58	108.62	108.70	107.87	108.50	108.30	109.50	110.07	110.13
G177.0	110.05	109.80	109.55	109.80	109.05	109.10	108.38	108.92	108.72	109.75	110.15	110.20
G178.0	109.95	109.80	109.57	109.93	109.37	109.45	108.83	109.25	109.05	109.93	110.13	110.20
G179.0	109.77	109.77	109.55	110.05	109.65	109.73	109.22	109.47	109.30	110.08	110.03	110.13
G180.0	109.53	109.65	109.45	110.10	109.83	109.95	109.53	109.65	109.45	110.10	109.83	109.95

Luminaire

Code 05-9683
Name 05-9683

Measur.

Code 20130314006
Name 05-9683

Luminaire Flux	225.03 lm	Luminaire Power	8.30 W	Efficacy	27.11 lm/W	Efficiency	37.51%
Lamps Flux	600.00 lm	Maximum value	110.20 cd/klm	Position	C=330.00 G=177.00	CG	Asymmetrical

100mm x 80mm

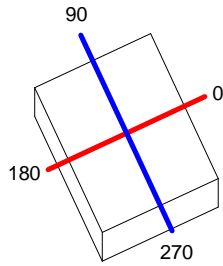

C Halfplanes

180.0 ———— 0.0
270.0 ———— 90.0

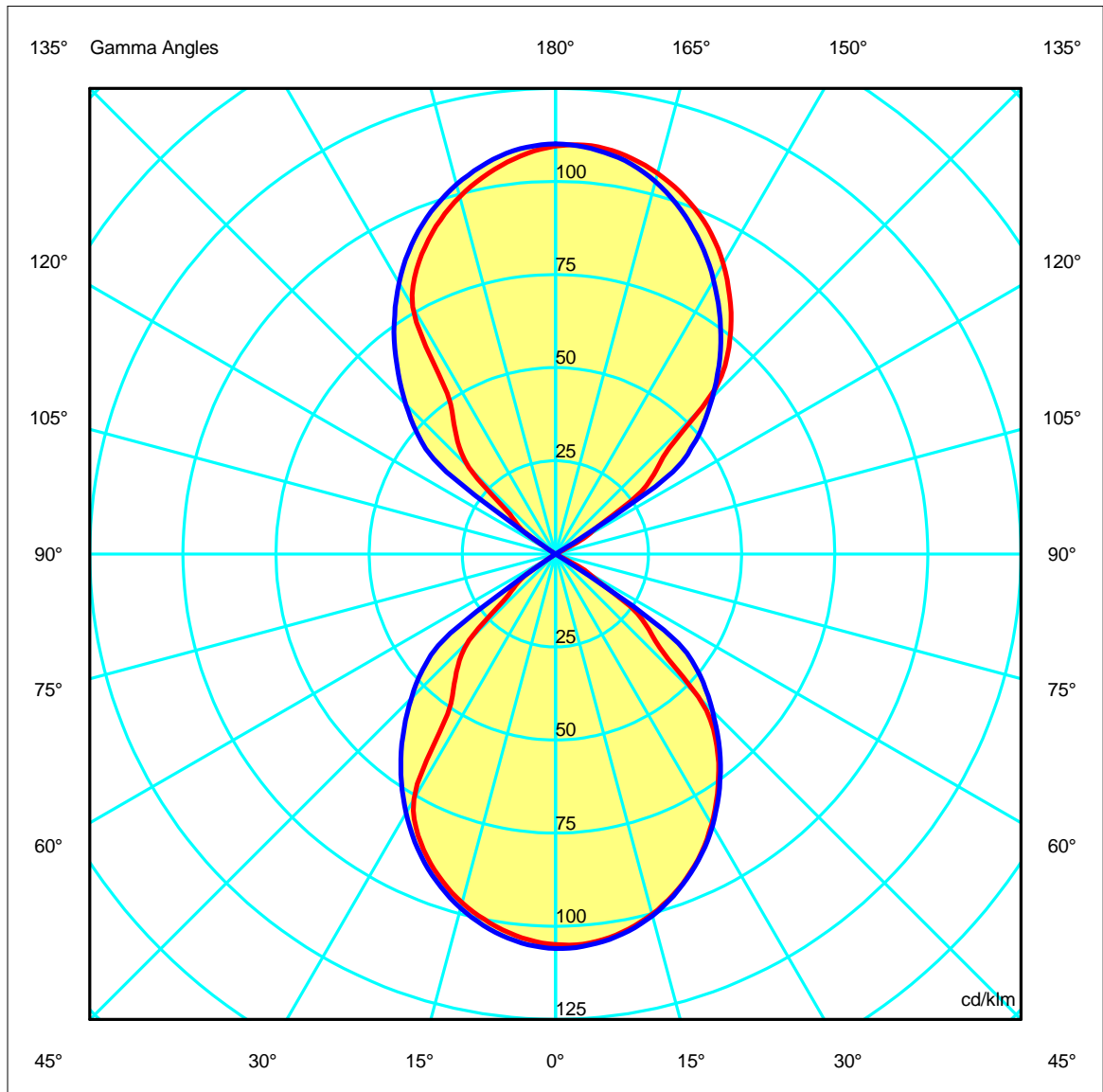

Luminaire

Code 05-9683
Name 05-9683

Measurement

Code 20130314006
Name 05-9683

Luminaire Flux	225.03 lm	Luminaire Power	8.30 W	Efficacy	27.11 lm/W	Efficiency	37.51%
Lamps Flux	600.00 lm	Maximum value	110.20 cd/klm	Position	C=330.00 G=177.00	CG	Asymmetrical

Width at 50.00 % of Max Intensity

H[m]	1.00	2.00	3.00	4.00	5.00	H[m]	1.00	2.00	3.00	4.00	5.00
OA	0.93	1.87	2.80	3.73	4.66	OC	1.10	2.20	3.30	4.40	5.50
OB	0.73	1.46	2.19	2.92	3.65	OD	1.04	2.09	3.13	4.18	5.22

	Luminous Intensities [cd/klm]									
	0	5	15	25	35	45	55	65	75	85
OA	65.72	66.02	63.51	58.07	49.16	33.43	14.80	0.00	0.00	0.00
OB	65.72	64.39	59.56	52.01	29.50	19.77	5.94	0.00	0.00	0.00
OC	66.06	65.58	62.12	55.28	46.26	35.76	23.08	0.00	0.00	0.00
OD	66.06	65.54	61.64	54.94	45.31	34.12	6.63	0.00	0.00	0.00

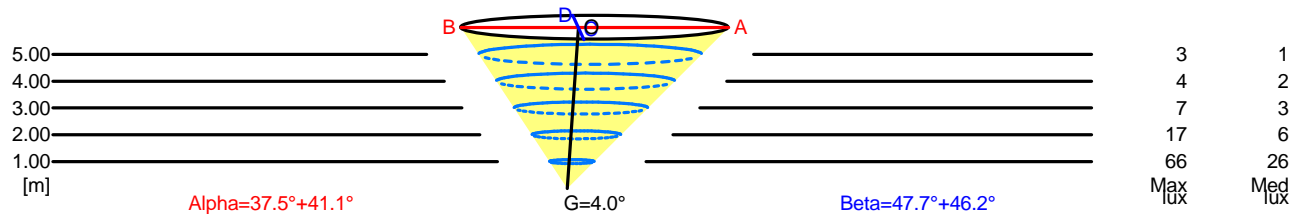

5.00	8.32	3	1	
4.00	6.65	4	2	
3.00	4.99	7	3	
2.00	3.33	17	6	
1.00	1.66	66	26	
H[m]	D[m]	Max lux	Med lux	

5.00	10.73	3	1	
4.00	8.58	4	2	
3.00	6.44	7	3	
2.00	4.29	17	6	
1.00	2.15	66	26	
H[m]	D[m]	Max lux	Med lux	

Luminaire

Code 05-9683
Name 05-9683

Measurement

Code 20130314006
Name 05-9683

Luminaire Flux	225.03 lm	Luminaire Power	8.30 W	Efficacy	27.11 lm/W	Efficiency	37.51%
Lamps Flux	600.00 lm	Maximum value	110.20 cd/klm	Position	C=330.00 G=177.00	CG	Asymmetrical

UGR
S = 0.250

Reflectancies										
Ceiling/Cavity	0.7	0.7	0.5	0.5	0.3	0.7	0.7	0.5	0.5	0.3
Walls	0.5	0.3	0.5	0.3	0.3	0.5	0.3	0.5	0.3	0.3
WorkingPlane	0.2	0.2	0.2	0.2	0.2	0.2	0.2	0.2	0.2	0.2
RoomDimensions	ViewedCrosswise					ViewedEndwise				
x=2H y=2H	8.1	8.8	8.9	9.6	13.8	11.2	11.9	12.1	12.7	13.8
x=2H y=3H	7.8	8.4	8.7	9.3	13.6	10.9	11.5	11.8	12.4	13.6
x=2H y=4H	7.6	8.2	8.6	9.1	13.4	10.8	11.3	11.7	12.2	13.4
x=2H y=6H	7.5	8.0	8.5	9.0	13.2	10.6	11.1	11.6	12.1	13.2
x=2H y=8H	7.4	7.9	8.4	8.9	13.2	10.6	11.0	11.5	12.0	13.2
x=2H y=12H	7.4	7.8	8.3	8.8	13.1	10.5	10.9	11.5	11.9	13.1
x=4H y=2H	8.0	8.5	8.9	9.4	13.5	10.9	11.5	11.8	12.4	13.5
x=4H y=3H	7.7	8.1	8.7	9.1	13.2	10.6	11.1	11.6	12.0	13.2
x=4H y=4H	7.5	7.9	8.5	8.9	13.0	10.5	10.9	11.4	11.8	13.0
x=4H y=6H	7.4	7.7	8.4	8.7	12.9	10.3	10.7	11.3	11.6	12.9
x=4H y=8H	7.3	7.6	8.3	8.6	12.8	10.2	10.5	11.2	11.5	12.8
x=4H y=12H	7.2	7.5	8.2	8.5	12.7	10.2	10.4	11.2	11.4	12.7
x=8H y=4H	7.3	7.6	8.3	8.6	12.8	10.2	10.5	11.2	11.5	12.8
x=8H y=6H	7.1	7.4	8.2	8.4	12.6	10.1	10.3	11.1	11.3	12.6
x=8H y=8H	7.1	7.3	8.1	8.3	12.6	10.0	10.2	11.0	11.2	12.6
x=8H y=12H	7.0	7.2	8.0	8.2	12.5	9.9	10.1	11.0	11.1	12.5
x=12H y=4H	7.2	7.5	8.2	8.5	12.7	10.2	10.4	11.2	11.4	12.7
x=12H y=6H	7.1	7.3	8.1	8.3	12.6	10.0	10.2	11.0	11.2	12.6
x=12H y=8H	7.0	7.2	8.0	8.2	12.5	9.9	10.1	11.0	11.1	12.5

Luminaire

Code 05-9683
Name 05-9683

Measur.

Code 20130314006
Name 05-9683

Luminaire Flux	225.03 lm	Luminaire Power	8.30 W	Efficacy	27.11 lm/W	Efficiency	37.51%
Lamps Flux	600.00 lm	Maximum value	110.20 cd/klm	Position	C=330.00 G=177.00	CG	Asymmetrical

100mm x 80mm

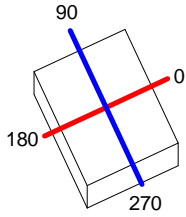

C Halfplanes

180.0 ———— 0.0
270.0 ———— 90.0

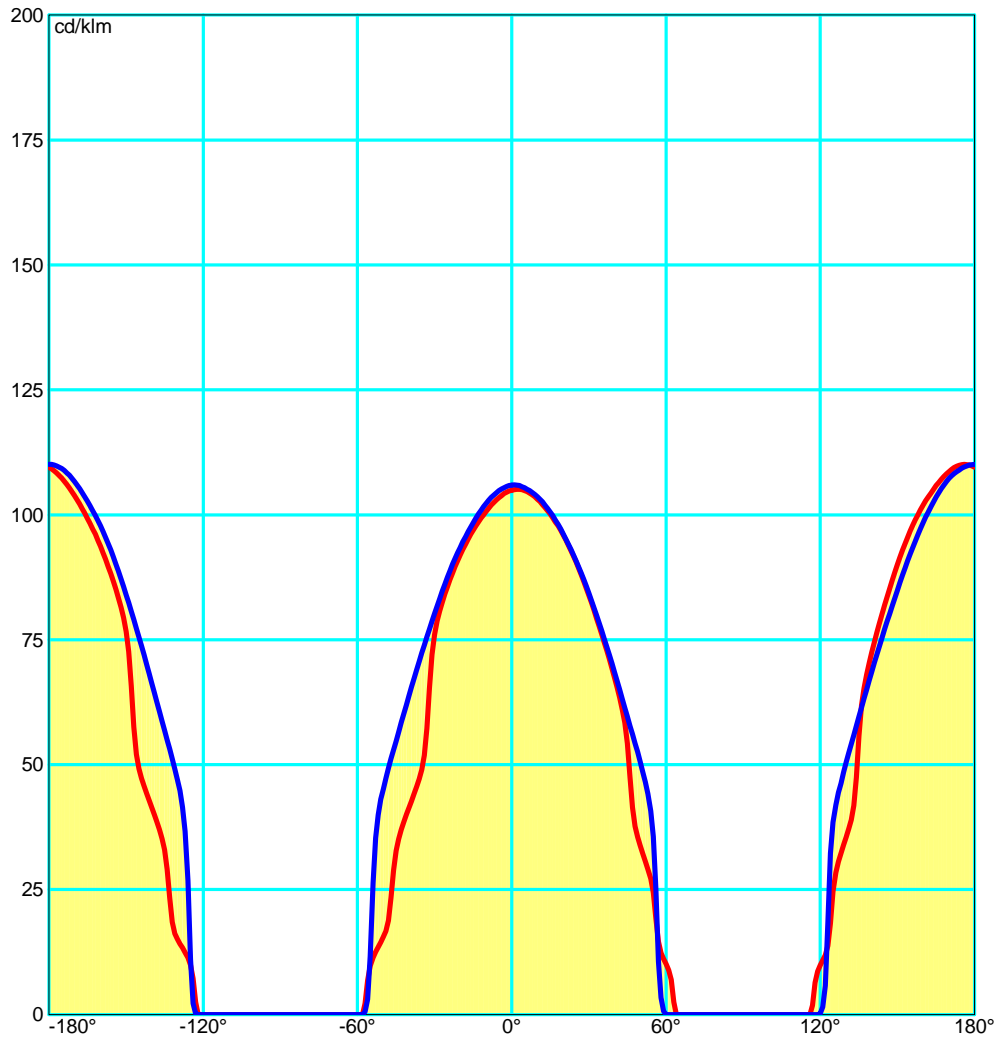

Luminaire
 Code 05-9683
 Name 05-9683
Measur.
 Code 20130314006
 Name 05-9683

Luminaire Flux	225.03 lm	Luminaire Power	8.30 W	Efficacy	27.11 lm/W	Efficiency	37.51%
Lamps Flux	600.00 lm	Maximum value	110.20 cd/klm	Position	C=330.00 G=177.00	CG	Asymmetrical

Luminance

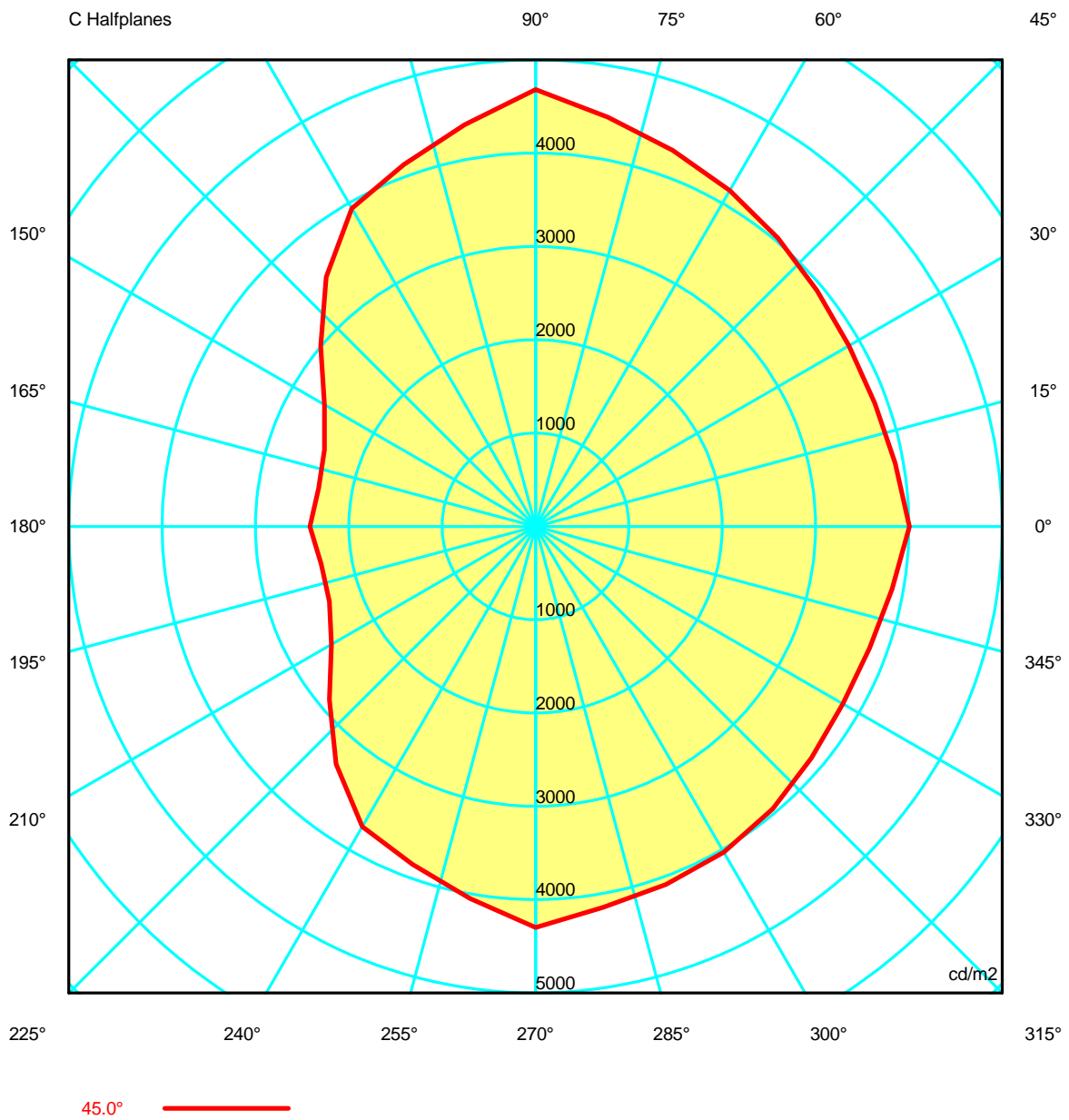

Luminaire

 Code 05-9683
 Name 05-9683

Measurerm.

 Code 20130314006
 Name 05-9683

Luminaire Flux	225.03 lm	Luminaire Power	8.30 W	Efficacy	27.11 lm/W	Efficiency	37.51%
Lamps Flux	600.00 lm	Maximum value	110.20 cd/klm	Position	C=330.00 G=177.00	CG	Asymmetrical

Luminance cd/m2 Table 1/3

	C 0.00	C 10.00	C 20.00	C 30.00	C 40.00	C 50.00	C 60.00	C 70.00	C 80.00	C 90.00	C 100.00	C 110.00	C 120.00
G 0.0	7867.50	7863.33	7859.17	7855.00	7834.28	7817.74	7822.50	7858.60	7907.86	7945.00	7951.77	7937.87	7920.00
G 5.0	7602.78	7555.42	7516.98	7487.06	7466.95	7465.36	7492.72	7553.79	7630.43	7698.21	7640.45	7572.88	7519.12
G 10.0	7291.81	7198.59	7128.15	7084.95	7072.68	7093.04	7147.16	7232.82	7334.23	7431.25	7322.24	7213.88	7130.88
G 15.0	6960.28	6833.76	6739.03	6681.12	6664.26	6690.10	6759.81	6870.88	7004.86	7137.87	6987.29	6842.92	6734.83
G 20.0	6605.00	6448.98	6334.41	6268.08	6254.92	6292.36	6376.44	6501.13	6650.77	6805.74	6618.86	6449.78	6328.37
G 25.0	6222.49	6044.22	5915.32	5843.39	5833.65	5880.86	5977.92	6116.59	6281.78	6454.98	6231.55	6035.17	5899.16
G 30.0	5796.13	5602.89	5465.14	5390.57	5384.40	5440.10	5549.25	5702.58	5883.93	6073.34	5816.59	5594.88	5448.31
G 35.0	5331.32	5127.33	4984.35	4910.51	4911.28	4978.19	5100.68	5267.23	5457.60	5646.37	5342.10	5091.22	4959.87
G 40.0	4825.67	4622.60	4485.40	4423.72	4442.29	4521.24	4635.77	4769.50	4941.10	5181.53	4985.66	4781.35	4472.36
G 45.0	4004.07	3909.97	3865.36	3873.67	3935.68	4036.64	4158.47	4290.36	4454.12	4683.93	4373.00	4126.91	3936.61
G 50.0	2594.76	2564.01	2563.32	2592.33	2906.22	3305.02	3664.08	3886.97	4022.48	4163.45	3860.51	3608.57	3335.56
G 55.0	1960.93	1924.36	1913.92	1928.61	2303.49	2760.82	3119.20	3236.18	3184.86	3105.09	2699.13	2387.61	2072.81
G 60.0	860.46	857.85	867.02	888.05	1022.37	1124.67	1064.93	750.84	319.44	0.00	16.99	253.04	525.24
G 65.0	0.00	161.14	268.89	294.72	223.83	104.75	0.00	0.00	0.00	0.00	0.00	0.00	0.00
G 70.0	0.00	0.00	0.00	0.00	0.00	0.00	0.00	0.00	0.00	0.00	0.00	0.00	0.00
G 75.0	0.00	0.00	0.00	0.00	0.00	0.00	0.00	0.00	0.00	0.00	0.00	0.00	0.00
G 80.0	0.00	0.00	0.00	0.00	0.00	0.00	0.00	0.00	0.00	0.00	0.00	0.00	0.00
G 85.0	0.00	0.00	0.00	0.00	0.00	0.00	0.00	0.00	0.00	0.00	0.00	0.00	0.00
G 90.0	0.00	0.00	0.00	0.00	0.00	0.00	0.00	0.00	0.00	0.00	0.00	0.00	0.00

Luminaire

Code 05-9683

Name 05-9683

Measur.

Code 20130314006

Name 05-9683

Luminaire Flux	225.03 lm	Luminaire Power	8.30 W	Efficacy	27.11 lm/W	Efficiency	37.51%
Lamps Flux	600.00 lm	Maximum value	110.20 cd/klm	Position	C=330.00 G=177.00	CG	Asymmetrical

Luminance cd/m2 Table 2/3

	C 130.00	C 140.00	C 150.00	C 160.00	C 170.00	C 180.00	C 190.00	C 200.00	C 210.00	C 220.00	C 230.00	C 240.00	C 250.00
G 0.0	7910.89	7907.42	7902.50	7891.24	7877.53	7867.50	7864.81	7863.46	7855.00	7835.44	7818.54	7822.50	7858.24
G 5.0	7500.28	7491.94	7494.24	7488.72	7486.07	7501.27	7467.08	7450.08	7434.40	7416.18	7408.49	7411.12	7473.27
G 10.0	7089.78	7078.25	7076.85	7072.65	7079.61	7118.59	7061.22	7034.43	7015.57	6990.17	6975.93	6998.38	7075.57
G 15.0	6682.58	6669.65	6670.98	6669.82	6683.66	6739.04	6656.94	6616.04	6588.72	6557.16	6540.99	6569.07	6662.48
G 20.0	6273.78	6251.48	6261.44	6254.34	6264.57	6329.60	6233.20	6191.34	6165.13	6128.99	6106.35	6132.74	6235.20
G 25.0	5842.45	5834.70	5834.63	5816.00	5814.22	5882.27	5779.99	5747.85	5731.59	5695.09	5666.18	5688.40	5795.97
G 30.0	5381.96	5355.91	5369.79	5290.57	5220.57	5256.85	5174.87	5203.23	5246.21	5238.03	5212.85	5228.69	5332.61
G 35.0	4847.60	4778.19	4749.98	4227.62	3660.86	3433.12	3602.42	4119.60	4605.94	4613.05	4659.88	4747.52	4890.47
G 40.0	4008.66	3502.70	3100.28	2910.51	2891.04	2962.48	2849.71	2830.96	2985.54	3354.75	3824.04	4240.85	4385.02
G 45.0	3490.44	3006.02	2612.03	2406.55	2361.04	2417.69	2333.04	2350.51	2525.57	2884.15	3324.25	3712.42	3855.50
G 50.0	2991.67	2586.90	2140.17	1683.39	1320.12	1190.01	1290.20	1622.64	2044.11	2447.67	2798.47	3074.18	3265.41
G 55.0	1698.39	1320.47	1018.45	851.77	790.81	784.64	722.87	753.13	953.96	1349.72	1738.82	1855.54	1525.39
G 60.0	707.53	763.25	667.31	415.60	134.06	0.00	146.29	409.51	585.65	540.12	344.17	111.61	0.00
G 65.0	0.00	0.00	0.00	0.00	0.00	0.00	0.00	0.00	0.00	0.00	0.00	0.00	0.00
G 70.0	0.00	0.00	0.00	0.00	0.00	0.00	0.00	0.00	0.00	0.00	0.00	0.00	0.00
G 75.0	0.00	0.00	0.00	0.00	0.00	0.00	0.00	0.00	0.00	0.00	0.00	0.00	0.00
G 80.0	0.00	0.00	0.00	0.00	0.00	0.00	0.00	0.00	0.00	0.00	0.00	0.00	0.00
G 85.0	0.00	0.00	0.00	0.00	0.00	0.00	0.00	0.00	0.00	0.00	0.00	0.00	0.00
G 90.0	0.00	0.00	0.00	0.00	0.00	0.00	0.00	0.00	0.00	0.00	0.00	0.00	0.00

Luminaire

 Code 05-9683
 Name 05-9683

Measur.

 Code 20130314006
 Name 05-9683

Luminaire Flux	225.03 lm	Luminaire Power	8.30 W	Efficacy	27.11 lm/W	Efficiency	37.51%
Lamps Flux	600.00 lm	Maximum value	110.20 cd/klm	Position	C=330.00 G=177.00	CG	Asymmetrical

Luminance cd/m2 Table 3/3

	C 260.00	C 270.00	C 280.00	C 290.00	C 300.00	C 310.00	C 320.00	C 330.00	C 340.00	C 350.00
G 0.0	7907.57	7945.00	7952.06	7938.23	7920.00	7910.10	7906.26	7902.50	7894.13	7881.80
G 5.0	7564.53	7659.25	7637.67	7603.70	7568.32	7540.78	7524.89	7522.96	7536.42	7563.81
G 10.0	7194.67	7334.41	7289.40	7242.61	7195.97	7152.69	7122.99	7118.48	7147.70	7207.56
G 15.0	6809.09	6987.61	6915.63	6848.31	6784.79	6726.85	6688.86	6687.88	6736.61	6830.44
G 20.0	6403.15	6615.78	6524.24	6443.31	6367.50	6295.97	6247.93	6247.05	6311.22	6434.49
G 25.0	5980.31	6221.40	6114.37	6023.56	5939.10	5857.61	5801.90	5800.65	5875.84	6020.91
G 30.0	5521.43	5779.16	5659.50	5564.30	5478.26	5394.44	5336.96	5336.98	5418.72	5576.12
G 35.0	5079.70	5319.13	5197.99	5097.59	5004.57	4913.80	4851.00	4848.93	4933.36	5098.42
G 40.0	4577.79	4824.57	4659.17	4582.13	4523.42	4439.54	4363.15	4343.51	4419.39	4585.20
G 45.0	4048.23	4297.64	4145.15	4081.46	4031.86	3948.84	3857.96	3799.73	3806.24	3876.84
G 50.0	3443.38	3711.98	3656.34	3637.56	3529.79	3261.11	2924.15	2642.70	2511.38	2510.69
G 55.0	1071.20	1017.11	1587.70	2425.75	2960.62	2558.87	2203.20	1878.72	1880.04	1906.87
G 60.0	0.00	0.00	275.33	582.62	815.44	909.78	909.60	875.29	852.87	848.82
G 65.0	0.00	0.00	0.00	0.00	0.00	102.83	219.72	289.31	263.96	158.18
G 70.0	0.00	0.00	0.00	0.00	0.00	0.00	0.00	0.00	0.00	0.00
G 75.0	0.00	0.00	0.00	0.00	0.00	0.00	0.00	0.00	0.00	0.00
G 80.0	0.00	0.00	0.00	0.00	0.00	0.00	0.00	0.00	0.00	0.00
G 85.0	0.00	0.00	0.00	0.00	0.00	0.00	0.00	0.00	0.00	0.00
G 90.0	0.00	0.00	0.00	0.00	0.00	0.00	0.00	0.00	0.00	0.00

Luminaire
 Code 05-9683
 Name 05-9683
Measur.
 Code 20130314006
 Name 05-9683

Luminaire Flux	225.03 lm	Luminaire Power	8.30 W	Efficacy	27.11 lm/W	Efficiency	37.51%
Lamps Flux	600.00 lm	Maximum value	110.20 cd/klm	Position	C=330.00 G=177.00	CG	Asymmetrical

PERCENTAGE ISOCANDLES

Projection: Equal Area Tilting Angle:0°

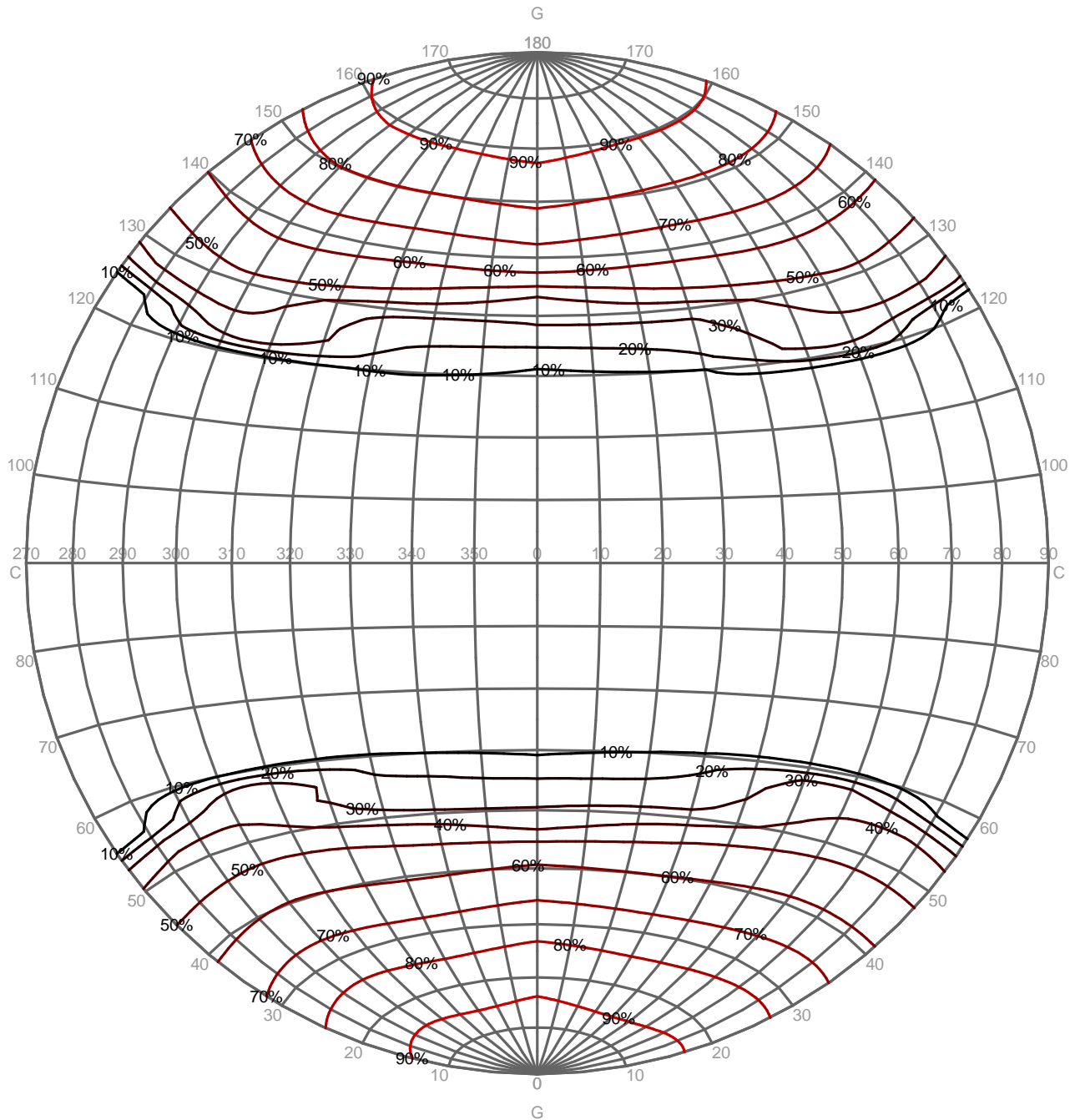

Luminaire
 Code 05-9683
 Name 05-9683
Measur.
 Code 20130314006
 Name 05-9683

Luminaire Flux	225.03 lm	Luminaire Power	8.30 W	Efficacy	27.11 lm/W	Efficiency	37.51%
Lamps Flux	600.00 lm	Maximum value	110.20 cd/klm	Position	C=330.00 G=177.00	CG	Asymmetrical

Isolux (Floor)

Luminaire position X=0.00m Y=0.00m Z=2.50m

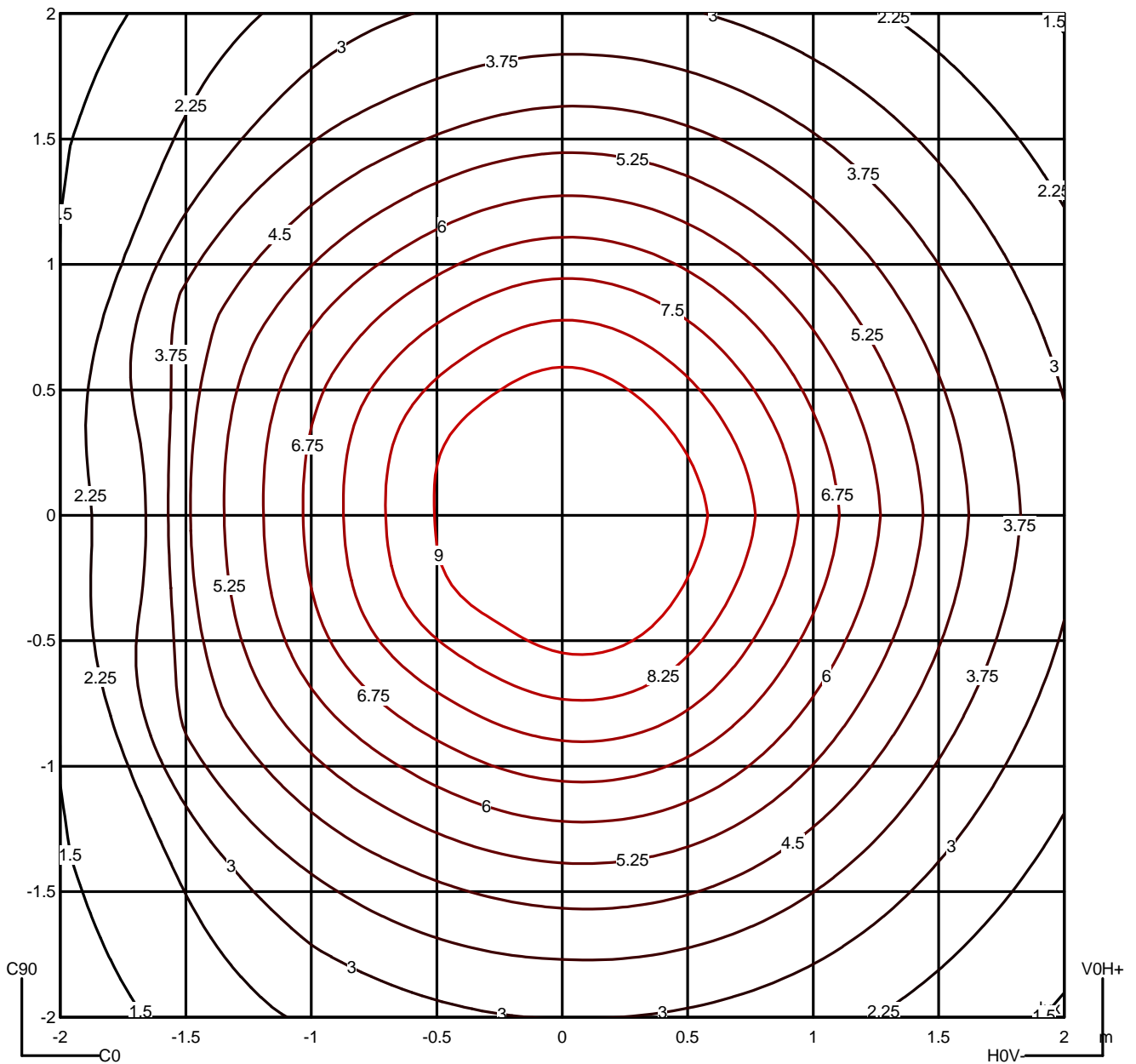

Luminaire

Code 05-9683
Name 05-9683

Measur.

Code 20130314006
Name 05-9683

Luminaire Flux	225.03 lm	Luminaire Power	8.30 W	Efficacy	27.11 lm/W	Efficiency	37.51%
Lamps Flux	600.00 lm	Maximum value	110.20 cd/klm	Position	C=330.00 G=177.00	CG	Asymmetrical

Average Luminance [cd/m ²]										
0.0°	45°	50°	55°	60°	65°	70°	75°	80°	85°	
4004	2595	1961	860	0	0	0	0	0	0	---
4684	4163	3105	0	0	0	0	0	0	0	---

Flush mounted or transversal view												
		Illumination(Ix)										
A	A	2000	1000	750	500		<300					1.15
B	1		2000	1500	1000	750	500	<300				1.5
C					2000		1000	500	<300			1.85
D	2						2000	1000	500	<300		2.2
E	3							2000	1000	500	<300	2.55

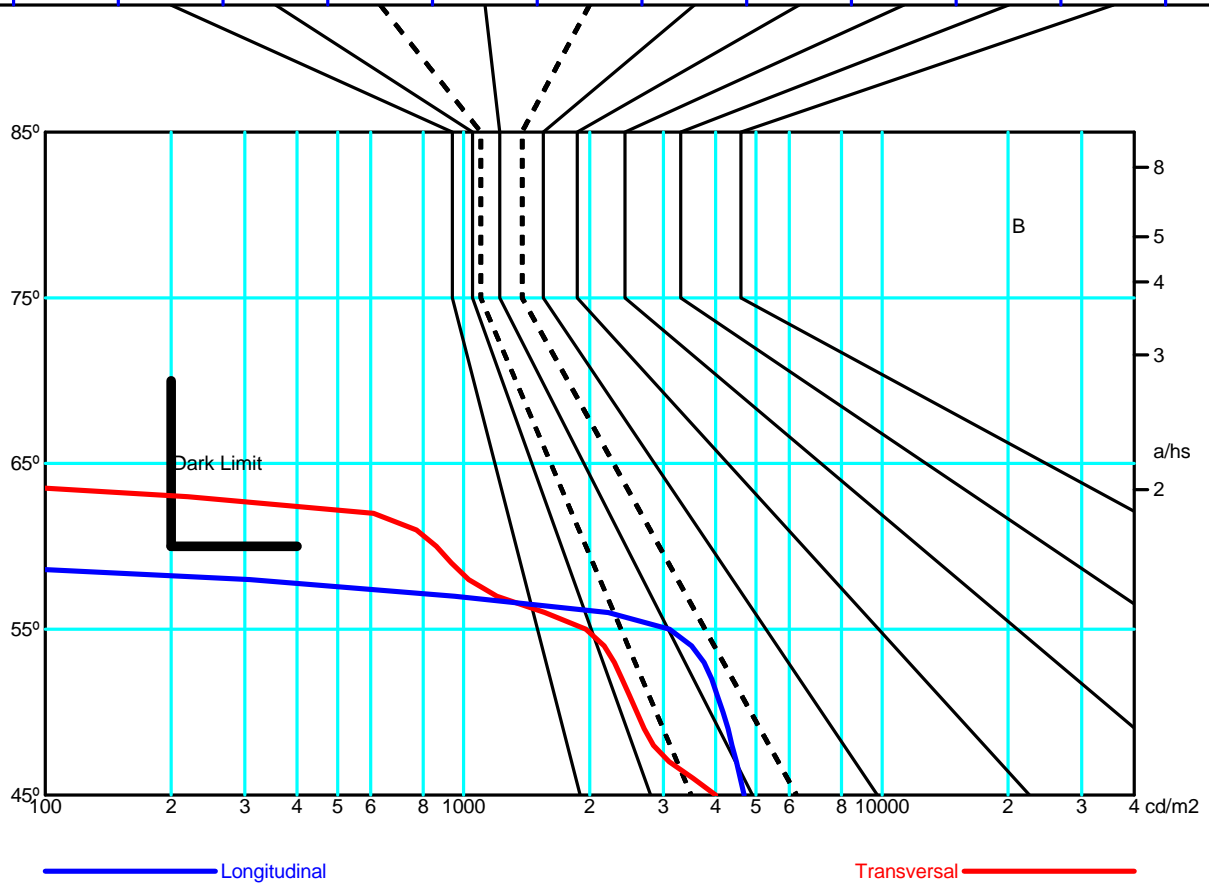
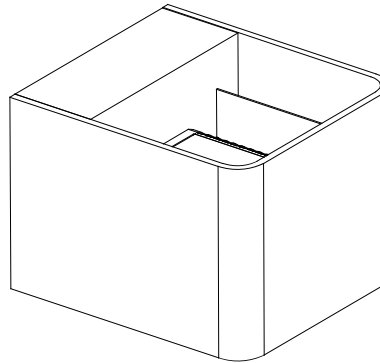
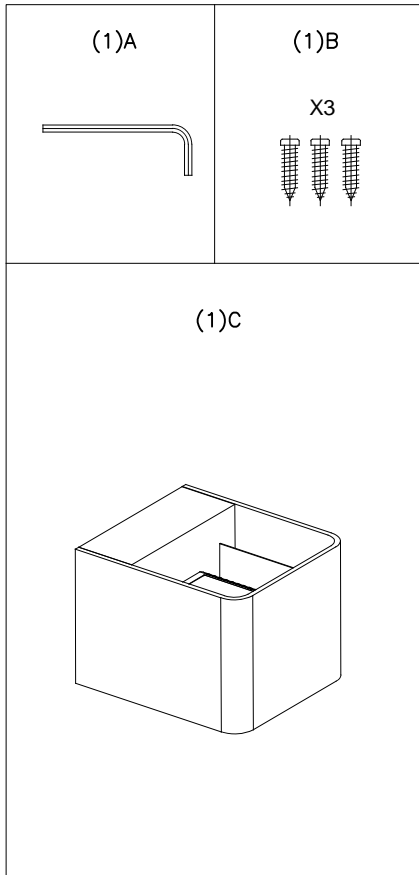

FIGURE N° 1. UNPACK THE FIXTURE: CHECK THE CONTENTS OF THE BOX. YOU SHOULD RECEIVE:

FIGURE N° 1. DÉBALLER LE PLAFONIER: VÉRIFIER LE CONTENU DU CARTON, VOUS DEVEZ RECEVOIR:

②



INSTALLATION INSTRUCTIONS FOR HANGING FIXTURES

INSTRUCTIONS D'INSTALLATION POUR PLAFONNIERS

FIGURE 3, 4 AND 5 MOUNTING HARDWARE.
NOTE: TEST THE CONNECTOR BY GENTLY PULLING IT. IF IT PULLS OUT THE CONNECTION, TRY AGAIN TILL YOU HAVE A FIRM CONNECTION. MAKE SURE NO BARE STRANDS OF WIRE STICK OUT FROM THE CONNECTORS.

FIGURE 3, 4 ET 5 MONTAGE DE L'ÉQUIPE.
IMPORTANT: ESSAYER DE TIRER LE CÂBLE D'ALIMENTATION DOUCEMENT. S'IL SORT DE LA CONNEXION, IL FAUDRAIT ASSURER QUE LA CONNEXION SOIT FERME. S'ASSURER QUE LES FILS DES CÂBLES NE SONT PAS À DÉCOUVERT DU CONNECTEUR.

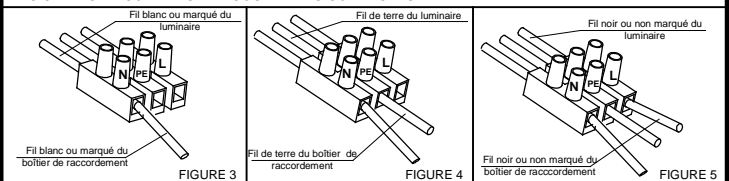
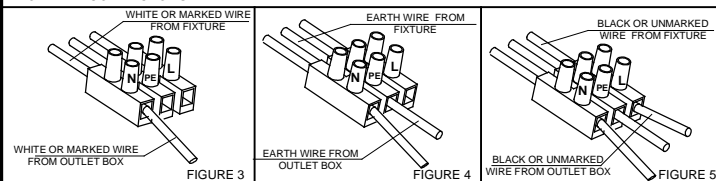

CAUTION:

"Warning", "This product is to be installed by a qualified electrician only."

"Product to be mounted recessed below ground"

"Suitable for wet locations"

ATTENTION:

"Attention", le raccordement électrique sera effectué par un technicien électricien qualifié"

Produit à monter en encastré de sol

"Convenient aux emplacements mouillés."

CAUTION:

- 1.- Wrong lighting installation can be dangerous for your safety.
- 2.- Before starting, disconnect the power by turning off the general switch of the electric installation.
- 3.- Install light bulbs (not provided) that must not exceed markings on the fixture.
- 4.- To change the bulbs, disconnect the power by turning off the general switch and wait for the bulbs cool down.

INSTALLATION:

- 1.- Make electrical connections, carefully read the Electrical Connection section.
- 2.- Assemble lighting as shown on fig. 6,7,8,9,10,11

ELECTRICAL CONNECTIONS: (See fig. 3,4 y 5)

- 1.- Connect the white wire from the fixture to the white wire of the electric installation.
- 2.- Connect the grounding conductor from the fixture to the grounding wire of the electric installation.
- 3.- Connect the black wire from the fixture to the black wire of the electric installation.

ATTENTION:

1. Une mauvaise installation peut compromettre votre sécurité.
2. Déconnecter la tension du réseau d'alimentation avant de réaliser toute opération.
3. Installer les ampoules (non fournies), ne pas utiliser d'ampoules d'un autre type ou d'une puissance supérieure à celle indiquée sur l'étiquette de la lampe.
4. Pour changer les ampoules, déconnecter la tension du réseau d'alimentation et laisser refroidir les ampoules.

INSTALLATION:

1. Connecter au réseau, lire attentivement la section de "Raccordements électriques"
2. Installer l'appareil comme indiqué dans les dessins 6,7,8,9,10,11

RACCORDEMENTS ÉLECTRIQUES (dessins 3,4 et 5)

1. Connecter le câble blanc de l'appareil au câble blanc de l'installation électrique.
2. Connecter le câble conducteur de prise de terre au câble de prise de terre de l'installation électrique.
3. Connecter le câble noir de l'appareil au câble noir de l'installation électrique.

