

CUBE Spotlight



Description



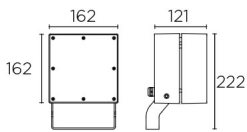

LED Spotlight for outdoor use.

With adjustable lighting positioning. Structure with double body design to prevent heat generated by the LED affecting the useful life of the driver. Includes 2 cable outlets to facilitate chain mounting. Adjustable light source. Structure material: High purity aluminium. Structure finish: Urban grey. Diffuser material: Polycarbonate. Diffuser finish: Transparent. UV protection. Warranty: 5 Years.



Finish
Urban grey
Transparent

Material
High purity aluminium
Polycarbonate

 IP65 IK10
  10°
  ±90°
  4

TECHNICAL CHARACTERISTICS

Light source

Light source: LED CREE

Output (W): 54W

Total power consumption (W): 62

Color temperature: Warm White - 3000K

CRI: 80

Photobiological risk: RG2

Real Lumen: 5015

Qty Leds: 16

Lm/Real W: 81

Life Time: 50.000h L90B10

Bin / Grup: 7C1 o 7B4

MacAdam steps: 3

UGR: 14.0

GEAR

Brand: HEP

Gear included: Yes, electronic

Voltage / Frequency: 100-240 VAC

Power Factor: 0.90

Luminaire

Double cable exit: Yes

Drainage: No

Uv Protection: Yes

Warranty: 5 Years

Logistics

Energy Efficiency: LED A++

EAN Code: 8435381455675

Net Weight (Kg): 2.318

Weight in Kg (packaged): 2.650

Packing: 235 x 170 x 180

Masterbox: 4

The photograph may not match the reference exactly. Please read the product description to identify the finish.

OPTIONAL ACCESSORIES



71-9943-Z5-Z5

Structure material: Aluminium
Net Weight (Kg): 0.120

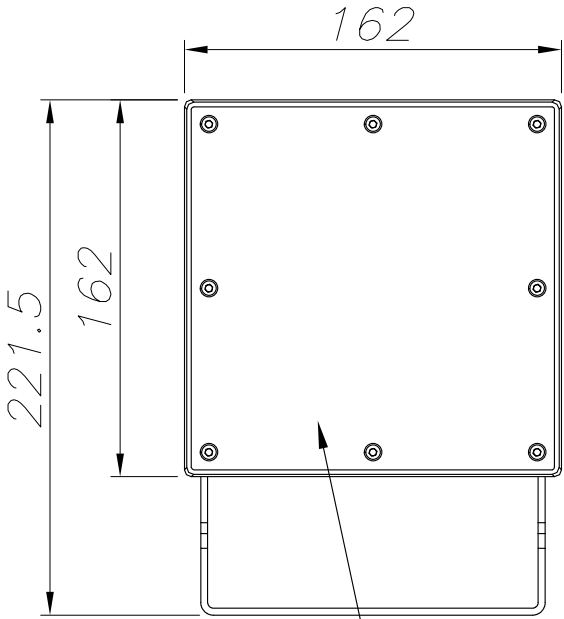

PC TRANSPARENTE
TRANSPARENT PC

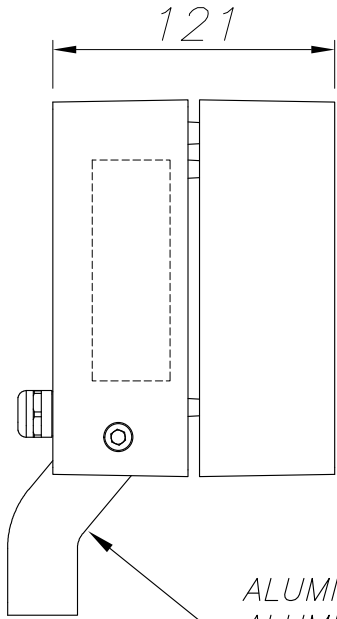

ALUMINIO
ALUMINIUM

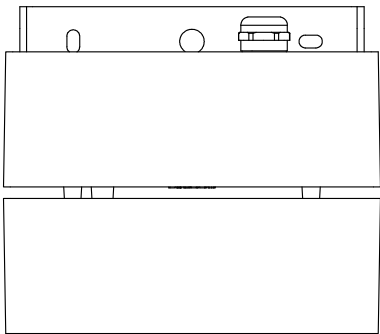

ALUMINIO INYECTADO
INJECTED ALUMINIUM

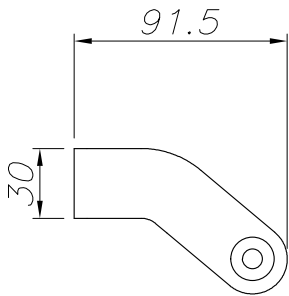
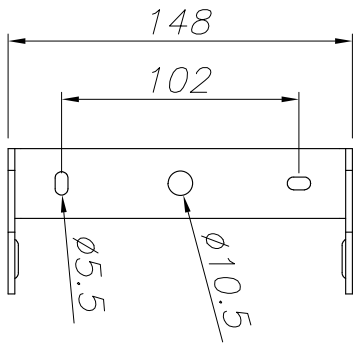

PLANTILLA DE INSTALACIÓN
INSTALLATION TEMPLATE

