

CUBE Spotlight



Description

LED Spotlight for outdoor use.

With adjustable lighting positioning. Structure with double body design to prevent heat generated by the LED affecting the useful life of the driver. Includes 2 cable outlets to facilitate chain mounting. Adjustable light source. Structure material: High purity aluminium. Structure finish: Urban grey. Diffuser material: Polycarbonate. Diffuser finish: Transparent. UV protection. Warranty: 5 Years.

Finish

Urban grey
Transparent

Material

High purity aluminium
Polycarbonate

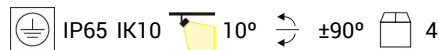
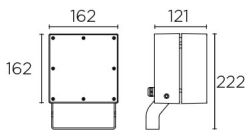

TECHNICAL CHARACTERISTICS

Light source

Light source: LED CREE
Output (W): 54W
Total power consumption (W): 62
Color temperature: Neutral white - 4000K
CRI: 75
Photobiological risk: RG2
Real Lumen: 5015
Qty Leds: 16
Lm/Real W: 81
Life Time: 50.000h L90B10
Bin / Grup: 5A3 o 5D2
MacAdam steps: 3
UGR: 14.0

GEAR

Brand: HEP
Gear included: Yes, electronic
Voltage / Frequency: 100-240 VAC
Power Factor: 0.90

Luminaire

Double cable exit: Yes
Drainage: No
Uv Protection: Yes
Warranty: 5 Years

Logistics

Energy Efficiency: LED A++
EAN Code: 8435381455705
Net Weight (Kg): 2.318
Weight in Kg (packaged): 2.650
Packing: 235 x 170 x 180
Masterbox: 4

The photograph may not match the reference exactly. Please read the product description to identify the finish.

OPTIONAL ACCESSORIES



71-9943-Z5-Z5

Structure material: Aluminium
Net Weight (Kg): 0.120

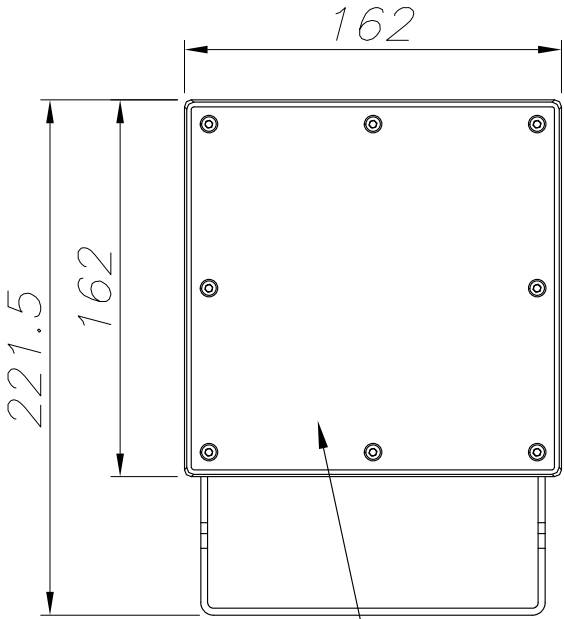

PC TRANSPARENTE
TRANSPARENT PC

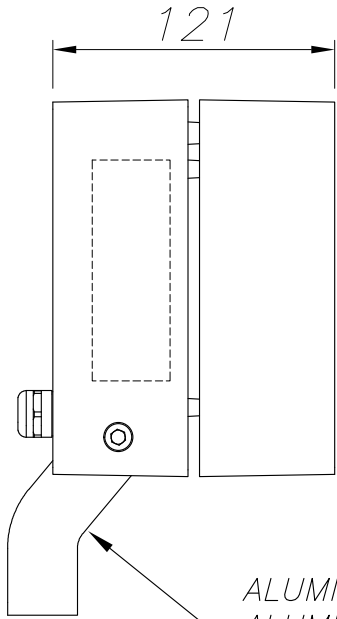

ALUMINIO
ALUMINIUM

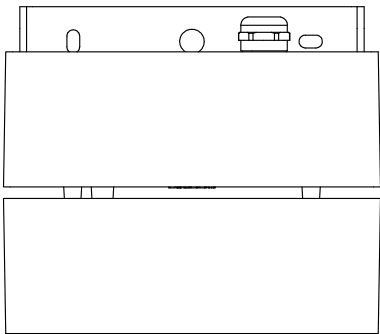

ALUMINIO INYECTADO
INJECTED ALUMINIUM

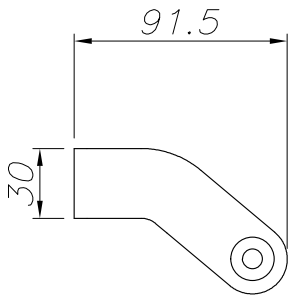
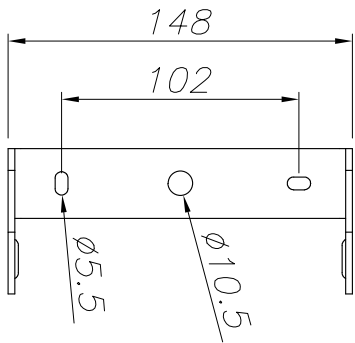

PLANTILLA DE INSTALACIÓN
INSTALLATION TEMPLATE

