

GEA Power Led Pro Uplight recessed

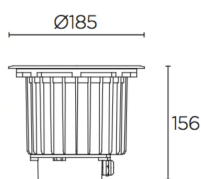

Description

Floor recessed for outdoor use.

For uplighting. Electronic components are in a sealed internal compartment, completely separate from the compartment where the connection terminals are located. The unit will withstand a static weight of 1,800 Kg and the occasional transit of slow-moving vehicles. Includes flush-mounting box. Suitable for installation in marine environments. Includes 2 cable outlets to facilitate chain mounting. Adjustable light source. Structure material: Stainless steel AISI316, Aluminium. Structure finish: Polished, Black. Diffuser material: Glass. Diffuser finish: Transparent. UV protection. Warranty: 5 Years. Ta max: 50°C.

Finish

Polished
Black
Transparent

Material

Stainless steel AISI316
Aluminium
Glass



TECHNICAL CHARACTERISTICS

Light source

Light source: LED CREE
Output (W): 16W
Total power consumption (W): 19.5
Color temperature: Warm White - 3000K
CRI: 80
Photobiological risk: RG2
Real Lumen: 1482
Qty Leds: 6
Lm/Real W: 76
Life Time: 50.000h L90B10
Bin / Grup: 7C1 o 7B4
MacAdam steps: 2
UGR: 9.3

GEAR

Brand: EAGLERISE
Gear included: Yes, electronic
Voltage / Frequency: 100-240 VAC
Power Factor: 0.90

Luminaire

Double cable exit: Yes
Drainage: Yes
Public Areas: 1800
Seaside: Yes
Uv Protection: Yes
Warranty: 5 Years
Ta max: 50°C

Logistics

Energy Efficiency: LED A++
EAN Code: 8435381463403
Net Weight (Kg): 2.327
Weight in Kg (packaged): 2.475
Packing: 190 x 190 x 175
Masterbox: 4

The photograph may not match the reference exactly. Please read the product description to identify the finish.

OPTIONAL ACCESSORIES



71-9995-DC-DC

Structure material: cement
Dimensions: 300 x 300 x 162
Net Weight (Kg): 12.000

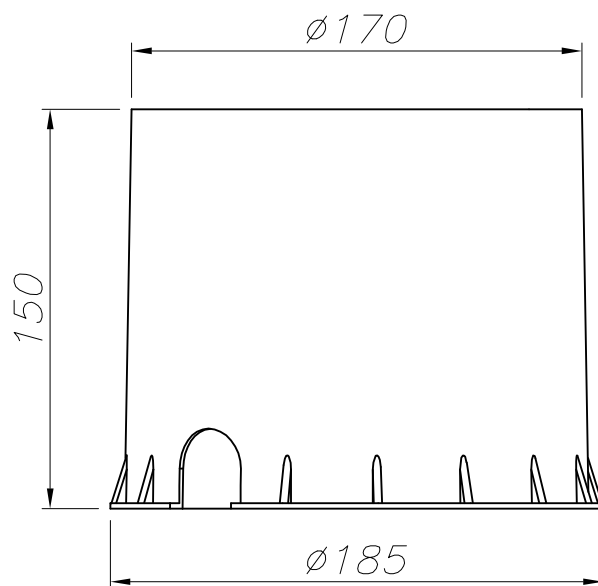
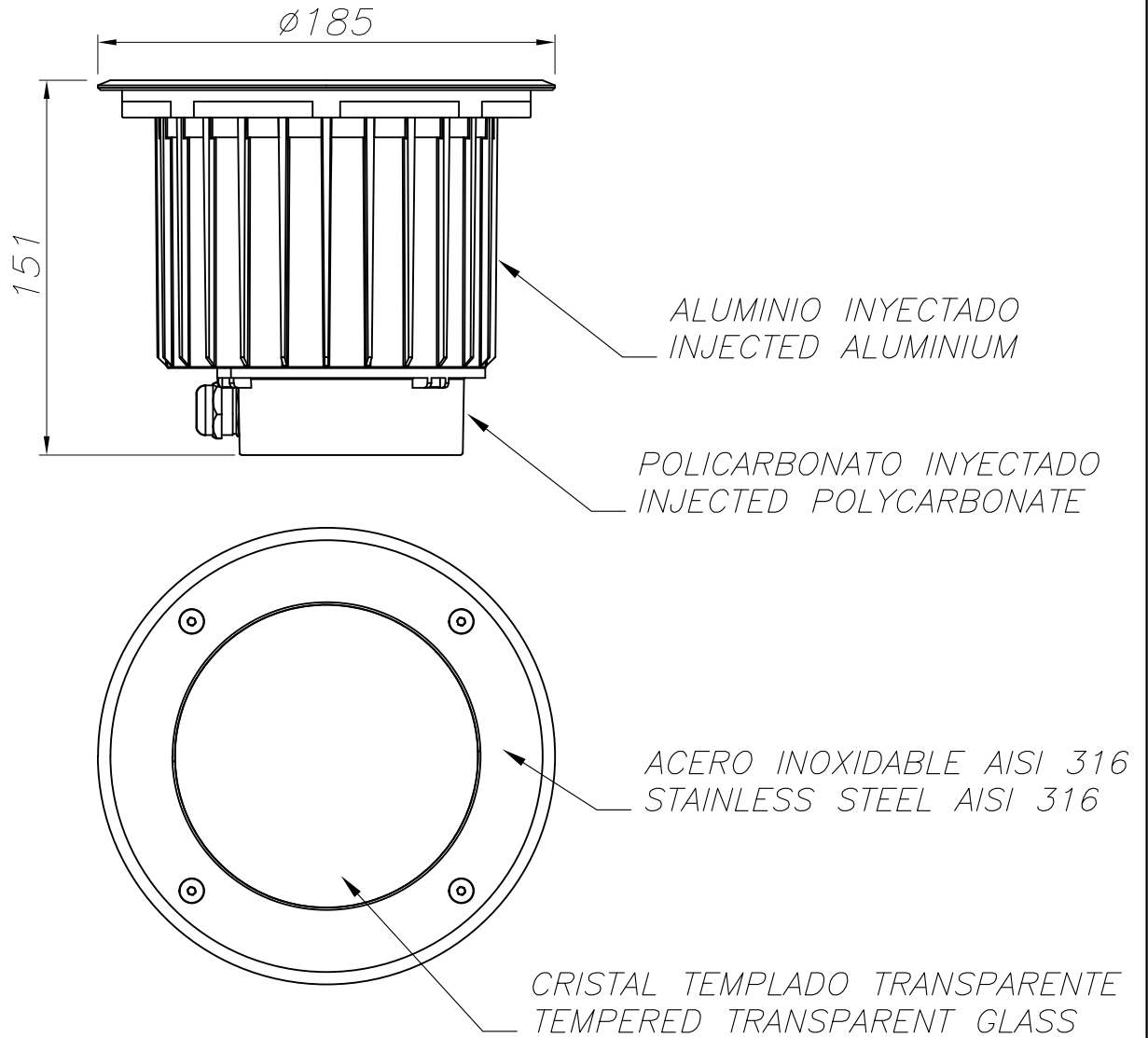

CAJA DE EMPOTRAR
FLUSH FITTING BOX

